

Intrinsic Safety Circuit Design

Making instruments intrinsically safe need not seem like a nightmare. Here, the basics of intrinsic safety circuit design are discussed.

Paul S. Babiarz

Intrinsic safety prevents instruments and other low-voltage circuits in hazardous areas from releasing sufficient energy to ignite volatile gases. Although it is used widely in Europe to safely install and operate instrumentation circuits in hazardous areas, it has caused much confusion in North American markets. Many users have heard of it and want to know more; however, most feel uncomfortable applying intrinsically safe products. One reason is that intrinsic safety has been a part of Section 504 of the National Electric Code only since 1990. In addition, the number of different products on the market and seemingly endless calculations make applying intrinsic safety seem like an engineer's nightmare.

This is the first of a series of short articles that explain how to make the most common field devices (thermocouples, RTDs, contacts, solenoid valves, transmitters, and displays) intrinsically safe. We will begin with an introduction to the practical side of intrinsic safety circuit design.

Start With The Field Device

All intrinsically safe circuits have three components: the field device, referred to as the intrinsically safe apparatus; the energy-limiting

Intrinsically Safe Apparatus	Intrinsically Safe Applications(%)
Switching	32.0%
mechanical switches	85.0%
proximity switches	15.0%
2-wire transmitters	22.0%
Thermocouples & RTDs	13.0%
Load cells	8.5%
Solenoid valves	4.5%
Potentiometers	2.5%
LEDs	2.0%
I/P transducers	2.0%
Other devices	13.5%
Total field devices	100.0%

Figure 1. Current use of intrinsically safe apparatus in hazardous areas.

device, also known as a barrier or intrinsically safe associated apparatus; and the field wiring. When designing an intrinsically safe circuit, begin the analysis with the field device. This will determine the type of barrier that can be used so that the circuit functions properly under normal operating conditions but still is safe under fault conditions.

More than 85% of all intrinsically safe circuits involve commonly known instruments. Figure 1 shows the approximate use of intrinsically safe apparatus in hazardous areas.

An intrinsically safe apparatus (field device) is classified either as a simple or nonsimple device. Simple apparatus is defined in paragraph

3.12 of the ANSI/ISA-RP 12.6-1987 as any device which will neither generate nor store more than 1.2 volts, 0.1 amps, 25 mW or 20 μ J. Examples are simple contacts, thermocouples, RTDs, LEDs, noninductive potentiometers, and resistors. These simple devices do not need to be approved as intrinsically safe. If they are connected to an approved intrinsically safe associated apparatus (barrier), the circuit is considered intrinsically safe.

A nonsimple device can create or store levels of energy that exceed those listed above. Typical examples are transmitters, transducers, solenoid valves, and relays. When these devices are approved as intrinsically safe, under the entity concept, they have the following entity parameters: V_{max} (maximum voltage allowed); I_{max} (maximum current allowed); C_i (internal capacitance); and L_i (internal inductance).

The V_{max} and I_{max} values are straightforward. Under a fault condition, excess voltage or current could be transferred to the intrinsically safe apparatus (field device). If the voltage or current exceeds the apparatus' V_{max} or I_{max} , the device can heat up or spark and ignite the gases in the hazardous area. The C_i and L_i values describe the device's ability to store energy in the form of internal capacitance and internal inductance.

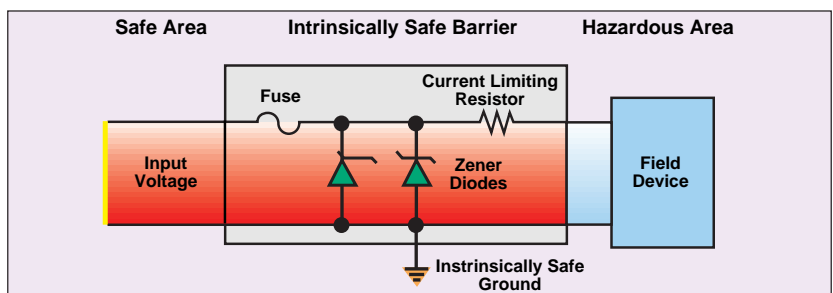

Figure 2. Barrier circuit

Limiting Energy To The Field Device

To protect the intrinsically safe apparatus in a hazardous area, an energy-limiting device must be installed. This is commonly referred to as an intrinsically safe associated apparatus or barrier. Under normal conditions, the device is passive and allows the intrinsically safe apparatus to function properly. Under fault conditions, it protects the field circuit by preventing excess voltage and current from reaching the hazardous area. The basic circuit diagram for an intrinsically safe barrier is shown in Figure 2.

There are three components to a barrier that limit current and voltage: a resistor, at least two zener diodes, and a fuse. The resistor limits the current to a specific value known as the short circuit current, I_{sc} . The zener diode limits the voltage to a value referred to as open circuit voltage, V_{oc} . The fuse will blow when the diode conducts. This interrupts the circuit, which prevents the diode from burning and allowing excess voltage to reach the hazardous area. There always are at least two zener diodes in parallel in each intrinsically safe barrier. If one diode should fail, the other will operate providing complete protection.

A simple analogy is a restriction in a water pipe with an overpressure shut-off valve. The restriction prevents too much water from flowing through the point, just like the resistor in the barrier limits current. If too much pressure builds up behind the restriction, the overpressure shutoff valve turns off all the flow in the pipe. This is similar to what the zener diode and fuse do with excess voltage. If the input voltage exceeds the allowable limit, the diode shorts the input voltage to

Associated Apparatus (barrier)	Apparatus (field device)
Open circuit voltage V_{oc}	$\leq V_{max}$
Short circuit current I_{sc}	$\leq I_{max}$
Allowed capacitance C_a	$\geq C_i$
Allowed inductance L_a	$\geq L_i$

Figure 3. Comparison of the entity values of an intrinsically safe apparatus and associated apparatus

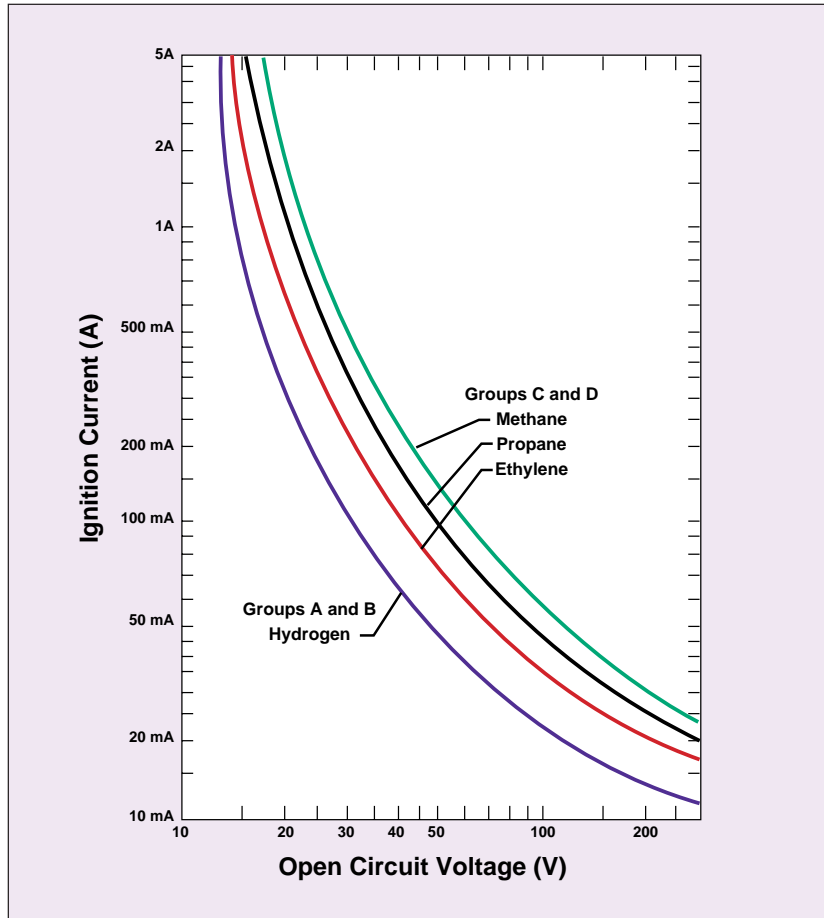

Figure 4. Ignition curves – resistance

ground and the fuse blows, shutting off electrical power to the hazardous area.

When conducting the safety analysis of the circuit, it is important to compare the entity values of the intrinsically safe apparatus against the associated apparatus. These parameters usually are found on the product or in the control wiring diagram from the manufacturer (see Figure 3).

Will The Circuit Work?

It also is important to make sure that the intrinsically safe circuit will work under normal conditions. With the current-limiting resistor, a voltage drop will occur between the input and output of the barrier. This has to be accounted for in your circuit design. In the subsequent articles in this series, a step-by-step explanation will be given on how to calculate these voltage drops and make sure that the circuit is safe.

Determining Safe Energy Levels

Voltage and current limitations are ascertained by ignition curves, as seen in Figure 4. A circuit with a combination of 30 V and 150 mA would fall on the ignition level of gases in Group A. This combination of voltage and current could create a spark large enough to ignite the mixture of gases and oxygen. Intrinsically safe applications always stay below these curves where the operating level of energy is about 1 watt or less. There are also capacitance and inductance curves which must be examined in intrinsically safe circuits.

The purpose of this series of articles is to simplify the application of intrinsic safety. Consider the ignition curves to demonstrate a point about thermocouples.

Intrinsic Safety Circuit Design Cont'd

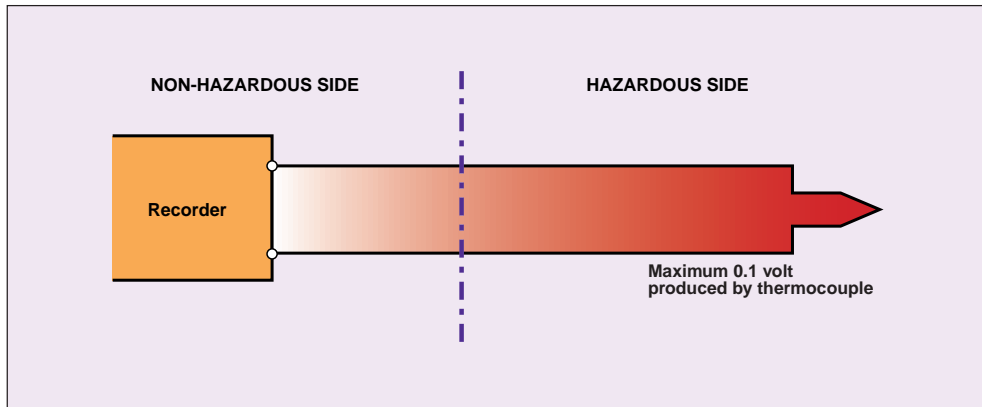

Figure 5. Thermocouple installed in a hazardous area



Figure 6. Thermocouple with fault

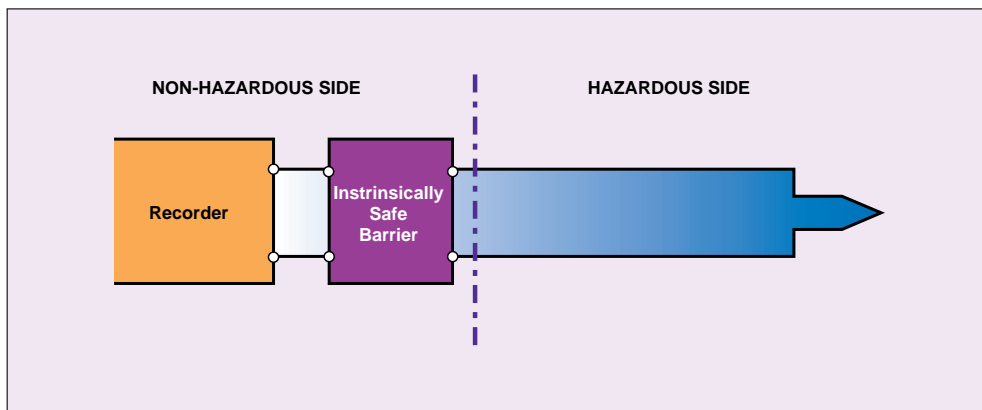

Figure 7. Thermocouple with barrier

A thermocouple is classified as a simple device. It will not create or store enough energy to ignite any mixture of volatile gases. If the energy level of a typical thermocouple circuit were plotted on the ignition curve in Figure 4, it would not be close to the ignition levels of the most volatile gases in Group A.

Is the thermocouple which is installed in a hazardous area (Figure 5) intrinsically safe? The answer is no, because a fault could

occur on the recorder which could cause excess energy to reach the hazardous area, as seen in Figure 6. To make sure that the circuit remains intrinsically safe, a barrier to limit the energy must be inserted (Figure 7).

The next installment in this series will explain how the selection is made for thermocouples and RTDs, which comprise about 13% of all intrinsically safe applications.

BEHIND THE BYLINE

Paul B. Babiarz is marketing manager of intrinsically safe products for Crouse-Hinds. He holds a B.S. from the University of Rochester, an M.S. from the University of Michigan, and an M.B.A. from Syracuse University. He has more than 13 years of experience in working in hazardous areas and has specialized in intrinsic safety. Copyright Instrument Society of America. Intech, October, 1992. All Rights Reserved.

Intrinsic Safety Circuit Design—Part 2

Fault conditions in hazardous-area temperature sensors can be explosive without the proper protection. You can safeguard all of the devices in your application with one type of intrinsic safety barrier.

Paul S. Babiarz

When thermocouples and RTD's (resistance temperature devices) are installed in hazardous areas, barriers are required to make their circuits intrinsically safe. These intrinsic safety barriers prevent excess energy from possible faults on the safe side from reaching the hazardous area. Without the barriers, excessive heat or sparks produced by the fault condition could ignite volatile gases or combustible dusts.

Hundreds of different barriers are available from North American suppliers. The multitude of products can give control engineers nightmares as they try to select the proper barrier for common instrumentation loops. The search can be simplified, however. One type of barrier can be selected to make all thermocouples and RTD's intrinsically safe so that polarity problems are avoided and calculations are not necessary.

Normally, the design of all intrinsically safe circuits centers on one of two approaches: the universal approach, which uses a universal device that often is isolated so that a ground for safety is not required; or the engineered approach, which uses grounded safety barriers.

■ **Isolated temperature converters.** These universal devices measure temperature in hazardous areas, but at a higher cost. (Dispensing with the need for a ground is a convenience that may cost two to three times as much as grounded safety barriers.) Isolated temperature converters accept a low-level DC signal from a thermocouple or 3-wire RTD and convert it into a proportional 4-20 mA signal in the safe area.

- They also are available with set points that trip an on-off signal to

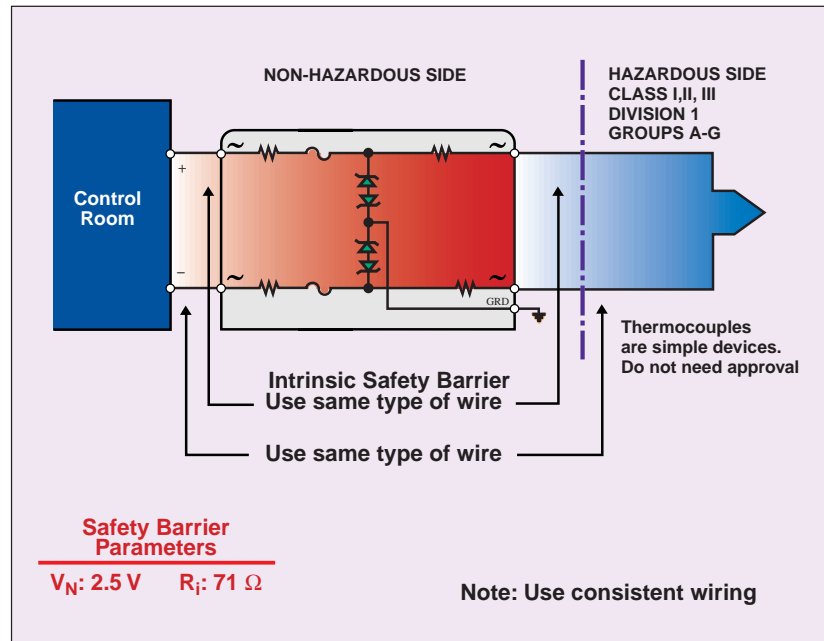

Figure 1. Current use of intrinsically safe apparatus in hazardous areas.

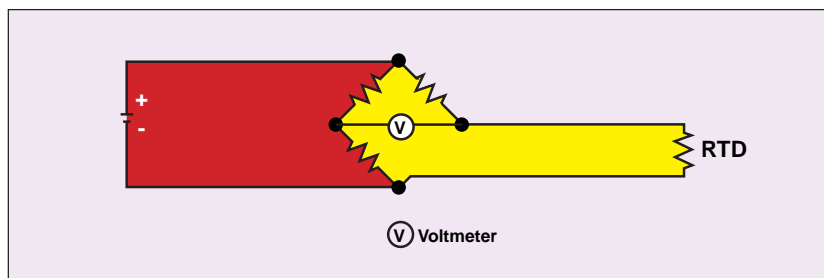

Figure 2. Typical values of barrier in thermocouple circuit.

the safe side when the temperature reaches a designated level. These units must be approved as intrinsically safe.

Advantages of isolated temperature converters as compared to grounded safety barriers include:

- Good signal response
- No ground required for safety

- More versatile application
- One product for all applications

Disadvantages include:

- Larger in size
- Requires calibration
- More expensive
- May not work with all thermocouples and RTD's

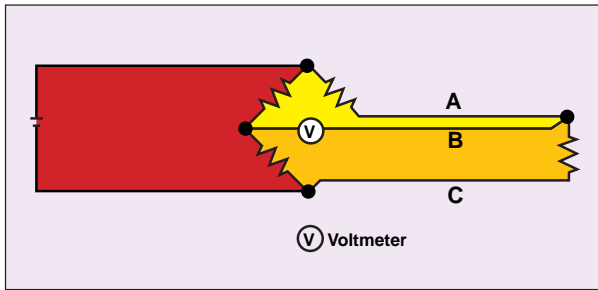

Figure 3. 3-wire RTD bridge

■ Grounded safety barriers.

These are passive devices that prevent all excess energy from a fault occurring on the safe side from reaching the hazardous area. Under normal conditions, the barriers allow the circuit to function properly by allowing the signals to pass between the field device and the control room. In a fault condition, the barriers limit voltage and current to levels that are not sufficient enough to ignite gases. For a more detailed explanation, refer to Part 1 of this series.

Advantages of grounded safety barriers as compared to isolated temperature converters include:

- Less expensive
- Precise signal response
- Very small (less than ½ in. wide)
- Simple application
- One barrier for all types of thermocouples and RTD's

Disadvantages include:

- Requires ground
- Requires some engineering

Examine The Barrier Parameters

Articles in this series will focus on methods to select the proper grounded safety barriers. Before we analyze thermocouple and RTD circuits, we should examine the functional parameters necessary to select the proper barrier. These parameters are: polarity of circuit; rated voltage of barrier; and resistance of barrier.

■ **Polarity.** The circuit's polarity must be known in order to choose the correct type of barrier. DC barriers are rated either as positive or negative. AC barriers can be connected to circuits with either a positive or negative supply. SIGNAL & RETURN barriers are used for transmitter and switching applications. All of these barriers are available in single- or double-channel versions. However, because double-channel barriers save space and money by being connected to two legs of a loop, they are becoming the standard.

■ **Rated voltage.** Like any electrical device, safety barriers have a rated nominal voltage, V_n , referred to as working voltage. The barrier's V_n should be greater than or equal to the supply to the barrier, much like the rated voltage of a lamp must be equal to or greater than the supply to it. If the voltage supply to the barrier is much greater than its V_n , the barrier will sense a fault. The protective zener diodes will conduct, causing leakage currents and inaccurate signals on the loop. Most barriers have a rated working voltage that guarantees a minimal leakage current from 1 to 10 micro amps if it is not exceeded. If the supply voltage to the barrier becomes too high, the zener diode will conduct. The resulting high current through the fuse will cause the fuse to blow. Excess supply voltage is the main reason why grounded barriers fail.

■ **Internal resistance.** Every safety barrier has an internal resistance, R_i , that limits the current under fault conditions. R_i also creates a voltage drop across the barrier. This drop can be calculated by applying Ohm's law, $V=IR$. Not accounting for the voltage drop produces the most problems in the proper functioning of intrinsically safe systems.

Thermocouple System Design Pointers

■ **Polarity.** A thermocouple has two wires, each with a positive and negative polarity. Two single-channel barriers, each with the proper polarity, could be used. Problems would occur if the positive leg to the thermocouple were connected to the negative terminal of the barrier or vice versa. There are two possible barrier choices for thermocouple circuits:

- Thermocouple circuit with one positive and one negative lead
- 1 standard DC barrier, positive polarity and
- 1 standard DC barrier, negative polarity OR
- 1 double AC barrier

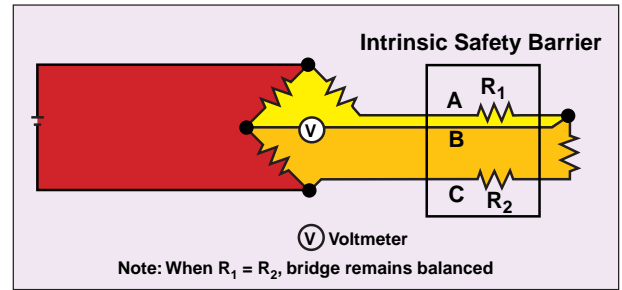

Figure 4. 3-wire RTD bridge with barrier

When barriers and thermocouples are being installed, the technician may forget which wire is positive and which is negative. To avoid polarity problems on the terminals, a double AC barrier should be used. The wires can be connected to either terminal and the circuit will function properly as long as thermocouple polarity is maintained throughout.

■ **Rated voltage.** A thermocouple produces a very small voltage (less than 0.1 V). It is connected to a voltmeter which has a high impedance and which requires a very small current. Since the thermocouple produces such a small voltage, choose a double AC barrier with a higher rated nominal voltage (V_n). A survey of most double AC barriers on the market shows that they are rated at low nominal voltages from 1 V and higher. Select one between 1 and 10 V.

■ **Internal resistance.** Since the mV signal has a very small current and is going to a high-impedance voltmeter, the resistance of the barrier will not influence circuit function. A simple rule of thumb is that when a signal is going to a high-impedance voltmeter, an internal barrier resistance of less than 1000 ohms will not affect the mV signal. It usually is good practice, however, to select a barrier with a low resistance in case the circuit is modified later.

■ **Barrier selection.** For proper operation of thermocouples in hazardous areas, select safety barriers based on the following parameters:

- Barrier type: double-channel AC barrier to avoid polarity problems
- Rated voltage: Barrier $V_n > 1V$
- Internal resistance: barrier with lowest resistance (less than 110 ohms)

■ **Safety and installation check.** Since the thermocouple is a simple device, it does not need third-party approval. Make sure that the barrier has the proper approvals for hazardous area locations. The thermocouple wires will be different

from terminal connections on the barrier. Always use consistent wiring from the thermocouple to the barrier and then to the control room. This will cancel any thermocouple effect caused by the dissimilar metals on the barrier connection.

RTD System Design Pointers

RTD's come in 2-, 3-, and 4-wire versions. The 3-wire RTD is used in more than 80% of all applications. The 2-wire version is not as accurate and is used mostly in the heating, ventilation, and air conditioning industry for set-point temperature measurements. The 4-wire RTD provides the most accurate signal, but is more expensive and requires one more extension wire to the process area.

Understanding RTD accuracy is essential in selecting the correct barrier. Many RTD measurements are in the form of a Wheatstone bridge, whose output voltage is a function of the RTD resistance. The bridge requires four connection wires, an external source, and three resistors that have a balanced temperature coefficient. The RTD normally is separated from the bridge by a pair of extension wires.

With a 2-wire RTD, the impedance of the barrier in series with the RTD will cause an imbalance on the bridge and will affect the accuracy of the temperature reading. This

effect can be minimized by using a third wire to measure the voltage (refer to Figure 3 for this discussion). If wires A and B are perfectly matched and if the resistance in both channels of the barrier is the same, the impedance effects will cancel because each is in an opposite leg of the bridge. The third wire, C, acts as a sense lead to the voltmeter.

■ **Current loop A & B: Polarity.** The current loop to the RTD has a positive and a negative polarity. Possible solutions are similar to the thermocouple:

- 1 standard DC barrier, positive polarity and
- 1 standard DC barrier, negative polarity OR
- 1 double AC barrier

Select the double AC barrier to avoid polarity problems. Because it is smaller, it is also less expensive.

■ **Current loop A & B: Rated voltage.** The constant current amperage sent to the RTD typically is in the micro amp (10^{-6}) level. The maximum resistance of the most commonly used RTD, Pt100 is 390 ohms at 1560°C. The voltage drop across the RTD will be in mV, so the V_n of the RTD loop is similar to the thermocouple. To be safe, select a barrier with a V_n greater than 1 V, similar to the V_n of the thermocouple barrier.

■ **Current loop A & B: Internal resistance.** The constant current source will have a rated maximum load or burden (resistance load it can drive). Assume that this maximum load is 500 ohms and the maximum resistance of the RTD at the highest temperature is 390 ohms. Knowing this information, the R_i of the barrier can be calculated:

$$\begin{array}{rcl} \text{control room} & \leq & \text{barrier} & + & \text{RTD} \\ \text{resistance} & & \text{resistance} & & \text{resistance} \\ 500 \text{ ohms} & < & R_i \text{ ohms} & + & 390 \text{ ohms} \\ R_i & < & 110 \text{ ohms} & & \end{array}$$

■ **Current loop A & B: Barrier selection.** Use the same barrier that was used for the thermocouple circuit.

■ **Leg C to the voltmeter: Barrier selection.** The RTD leg going to the voltmeter (C) is a millivolt signal similar to the thermocouple circuit. The rated voltage, V_n , and internal resistance, R_i , of the barrier will have the same parameters as the barriers used in the thermocouple and current loop of the RTD. Selecting the correct barrier to make all thermocouples and RTD's intrinsically safe is not difficult. Use a double-channel AC barrier with a rated voltage greater than 1 volt with the lowest internal resistance. The double-channel barrier is the lowest cost solution. The AC version will avoid any polarity problems. A barrier with a rated voltage between 1 and 10 volts will provide a wide selection which have a low resistance and are approved for the hazardous areas where the temperature sensors are located. This single barrier can then be used to make all thermocouples and RTD's intrinsically safe. And don't forget, all thermocouples and RTD's are simple devices, so they do not need third party approval to be intrinsically safe. When they are connected to an approved intrinsically safe barrier, the circuits are intrinsically safe.

Many temperature sensors are attached to 4-20 mA temperature transmitters, which comprise 22% of all intrinsically safe applications. The next article in this series will show how to make these transmitters intrinsically safe.

Copyright Instrument Society of America. Intech, December, 1992. All Rights Reserved.

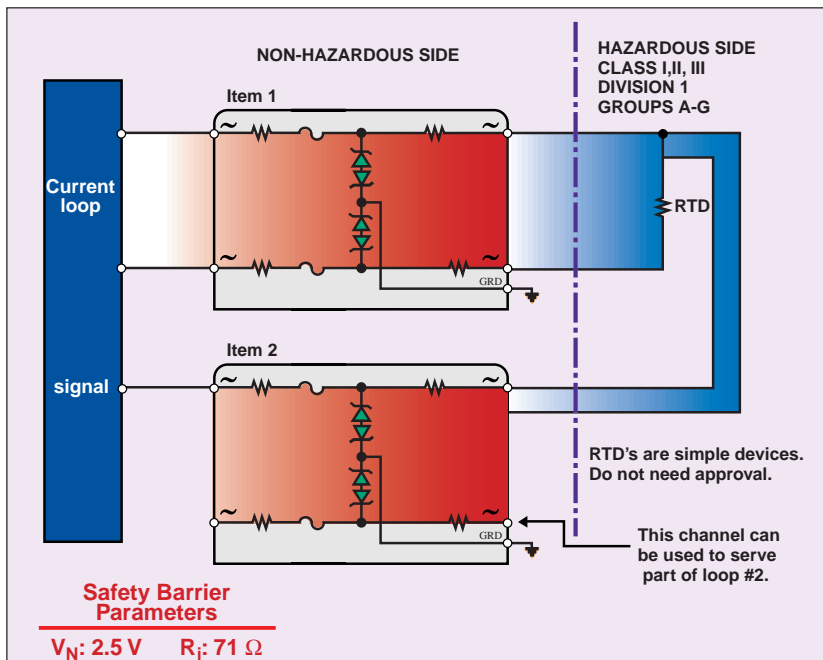

Use The 80/20 Rule In Intrinsic Safety Circuit Design

Part 3 of this series on intrinsic safety circuit design describes how to select barriers for intrinsically safe 4-20 mA transmitters. Use the 80/20 Rule to simplify this process.

Paul S. Babiarz

The 80/20 Rule actually is five rules that are based on the fact that certain practices prevail 80% of the time, and 20% of applications are more difficult. This article focuses on how to choose intrinsically safe barriers when the transmitters are installed in hazardous areas for both the 80% standard category and the remaining 20% more difficult applications.

The most common way to process and send analog signals in the instrumentation industry is via 4-20 mA transmitters. Transmitters can be one of the simplest devices involving barriers. However, improper selection of intrinsically safe barriers in loops with 4-20 mA transmitters can introduce too much impedance on the circuit and cause the transmitters to function improperly at the high end near the 20 mA reading.

Before selecting barriers, examine how 4-20 mA analog circuits function. Transmitters convert a physical measurement such as temperature or pressure into an electrical signal that can be sent without signal modification to a

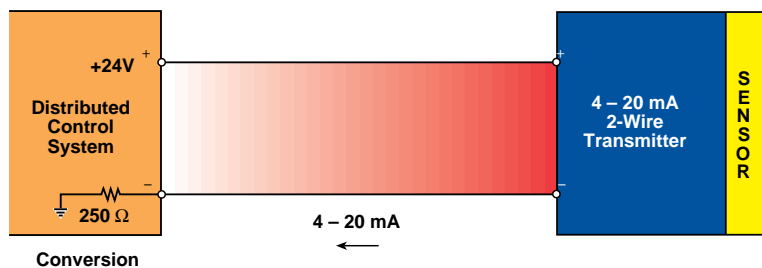

Figure 1. 4-20 mA 2-wire transmitter.

control system over a long distance. The brains of the system, the DCS, interprets the electrical signal into the physical measurement. Because these analog signals are sent to a DCS, 4-20 mA circuits are called analog inputs or A/I. Using temperature as an example, examine the function of the transmitter (Fig. 1).

A power source in the DCS usually supplies 24 VDC to the transmitter. The transmitter converts the physical measurement into an electrical current signal. Transmitter current ranging from 4-20 mA is sent back to the DCS. Current signals are used to avoid potential voltage drops or electrical interference associated with voltage signals. However, because the

controller reads a voltage signal, a conversion resistor (most commonly 250 ohms) converts the 4-20 mA current range into a voltage signal on the DCS input channel. Applying Ohm's Law of $V = IR$, the controller has a 1-to-5 V signal (Table 1).

Assume the temperature span to be measured is from 0°C to 100°C. The transmitter is calibrated so that a 4 mA signal equals the low reading of 0° and a 20 mA signal equals the high reading of 100°. The DCS then runs the signal through a conversion resistor which can be placed either on the supply (+) or return (-) lead of the circuit, converting the signal back to a voltage reading.

There are three types of barriers for intrinsically safe transmitter applications: ungrounded repeaters, grounded repeaters, or grounded safety barriers. Each has its advantages and disadvantages (Table 2).

Ungrounded repeater barriers, also known as galvanically isolated or transformer-isolated barriers, are used more frequently in Europe

Temperature	→ converted to mA signal	x multiplied by ohm resistor	= converted to a voltage reading in the DCS
0°C (min)	→ 4 mA (0.004 A)	x 250	= 1 V
100°C (max)	→ 20 mA (0.020 A)	x 250	= 5 V

Table 1. Conversion of physical measurement to electrical signals.

	Advantages	Disadvantages
Grounded Safety Barrier	Least expensive Precise signal response Very small size (<½ in. wide)	Requires ground Requires engineering
Grounded Repeater	One product can be used Can use transmitters with higher operating voltage	More expensive Requires ground Larger in size Consumes more power
Ungrounded Repeater	One product can be used No ground required Can use transmitters with higher operating voltage Isolation, if good ground not available	Most expensive Larger in size (1 in. wide) Possible radio frequency interference May not be compatible with smart transmitters

Table 2. Advantages and disadvantages of grounded safety barriers, grounded and ungrounded repeaters.

than in North America. Repeaters suit most transmitter applications, but at a higher cost. Grounded or ungrounded repeaters supply a constant regulated voltage of 15 to 17 V to the transmitter from a 24 V source. The return channel is then run through the barrier, which repeats it without any appreciable loss in signal. For example, if a transmitter sends 19.6 mA through the barrier, it is repeated in the barrier without any loss so that 19.6 mA reaches the control room. Repeaters act like mirrors by retransmitting, or repeating, the analog signals.

When budget constraints or control panel space are important considerations, grounded safety barriers may be a better choice.

80/20 Rule #1: In North America, most analog circuits are protected by grounded safety barriers because of lower costs.

Define the hazardous area where the transmitter is located.

In North America, these areas are defined by the National Electric Code as *classes, divisions, and groups*. The *class* defines the type of materials that are in the hazardous area. Class I — flammable gases and vapors; Class II — combustible dusts; Class III — fibers and flyings. Hazardous areas are further broken down into two *divisions*. Division 1 means normally hazardous; Division 2 means not normally hazardous. The *group*

designates the type of vapor or dust in the area. Group A — acetylene; Group B — hydrogen; Group C — ethylene; Group D — propane; Group E — metal dust; Group F — coal dust; Group G — grain dust.

Complex devices. Because transmitters can store energy, they are considered complex devices, and must be approved as intrinsically safe. If they are third-party approved, they have entity parameters such as V_{max} ,

I_{max} , C_i , and L_i (see Part 1 of this series).

Selection of safety barriers. The proper barrier must be selected by two separate evaluations: one to determine that the analog circuit functions properly at 20 mA, and one to determine that the circuit is safe under fault conditions.

Functional parameters: Type of safety barrier, voltage input (V_n), and internal resistance (R_i). The type of safety barrier is largely determined by the placement of the conversion resistor. If the resistor is placed on the supply leg of the circuit, a simple DC positive barrier can be used (Fig. 2).

80/20 Rule #2: Most transmitter circuits have the conversion resistor on the return channel. Use the double channel supply and return barrier.

The supply channel is constructed like the positive DC barrier; it prevents a fault on the safe side from transferring excess energy to the transmitter. The return channel has two diodes in series which allow the signal to pass only in one direction back to the DCS, and prevent any excess fault energy from being transferred to the transmitter. These diodes and the supply channel have voltage drops which must be accounted for in the analog circuit (Fig. 3).

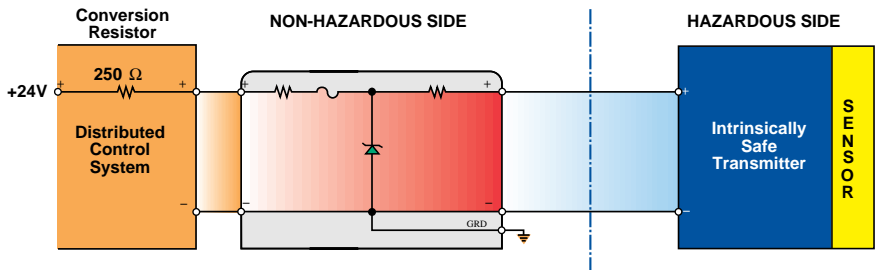

Figure 2. Positive DC barrier.

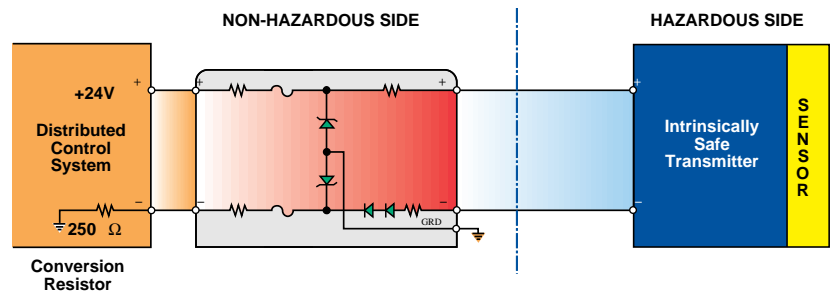

Figure 3. Supply and return barrier.

80/20 Rule #3: The supply voltage normally is 24 VDC.

■ **Select the voltage input, V_n .** One of the reasons that barriers fail is because the voltage supply is too high. Use a regulated supply source with a high end of tolerance that does not exceed the barrier rating and a low end that is enough to drive the circuit. A 24 Vdc source $\pm 1\%$ usually is a good choice.

■ **Determine the internal resistance, R_i (also referred to as end-to-end resistance) of the barrier best suited for your circuit.** The most critical component of the barrier selection is the barrier's internal resistance. If the resistance is too high, the transmitter will not work near 20 mA. As seen in Table 1 and the following discussion, at 20 mA the voltage drops across the barrier and the conversion resistor will be the highest. If the internal resistance is too low, the barrier's short circuit current, I_{sc} , may exceed the transmitter's entity parameter, I_{max} .

The easiest way to determine the barrier's permitted resistance is to calculate the total voltage drop on the circuit. To select the proper transmitter barrier, determine the following:

- Hazardous area Groups A-G or C-G
- Placement of the conversion resistor on either the supply or return leg of the circuit
- Size of the conversion resistor (250 ohms is most common)
- Minimum operating voltage of the transmitter (This figure, also referred to as lift-off voltage, is in the transmitter data sheet. Most operate at a minimum of 12 V or lower.)
- Entity parameters of approved transmitter

■ **Case 1.** Assume that conditions are as follows:

- Groups A-G
- Supply
- 250 ohms
- 12 V
- $V_{max} = 30\text{ V}$, $I_{max} = 150\text{ mA}$, $C_i = 0\text{ }\mu\text{F}$, $L_i = 0\text{ mH}$

Calculate the maximum allowable resistance of the barrier under worst-case conditions when the transmitter is sending a 20 mA signal. The supply is 24 Vdc; the transmitter requires a minimum of 12 V; and the 250 ohm conversion

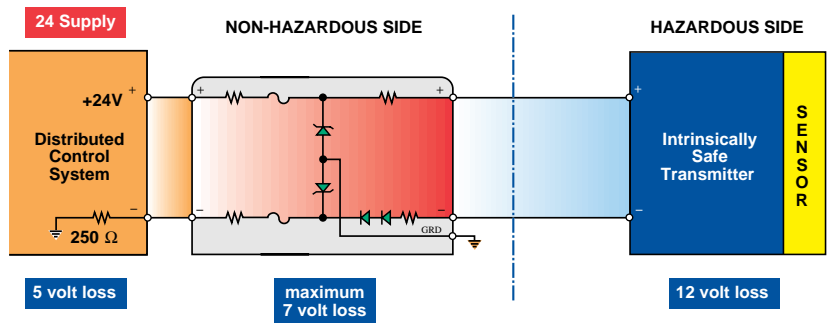

VOLTAGE BALANCE:
 Transmitter = 12 volts
 Resistor = 5 volts
 Barrier(+ line loss) = 7 volts
 Total Supply = 24 volts

Figure 4. Voltage balance.

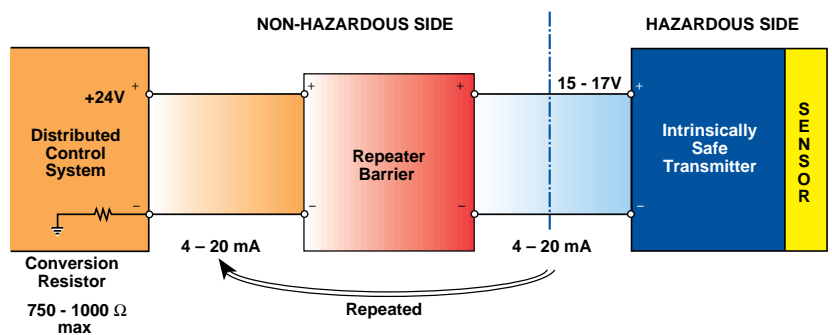

Figure 5. Repeater barriers.

resistor requires 5 V at 20 mA. Simple subtraction leaves a maximum allowable voltage drop of 7 V. Using Ohm's Law, this converts to an internal resistance of 350 ohms. Allow for a cable resistance of about 10 ohms. Thus, the circuit functions properly with a barrier having an internal resistance of 340 ohms.

Next, to make sure the circuit is safe, verify that the barrier's entity parameters match the transmitter's entity parameters. This design offers the lowest cost solution where two transmitters can be connected to one double channel barrier. This circuit arrangement allows one common barrier to be used for most circuits (Fig. 4).

■ **Case 2.** Use the same conditions as in Case 1, except change the placement of the conversion resistor to the return side, and use the supply and return barrier. Voltage drop on the barrier occurs on both the

supply and return side. Voltage drop on the return side diodes is about 0.7 V. This leaves a maximum drop of 6.3 V on the supply side or a maximum resistance of 305 ohms (allowing 10 ohms for cable resistance). Again, verify the entity parameters of the barrier and transmitter.

80/20 Rule #4: The two solutions above cover 80% of all transmitter applications.

But what happens if the circuit falls into the 20% category? Grounded safety barriers may not work in conditions where a loop-powered indicator is connected, or where the transmitter requires a minimum voltage greater than 12 V. In these cases, the easiest solution is to use a repeater barrier. Repeaters provide a regulated power supply of 15-17 V to the transmitters and can drive a conversion resistor load of 750 to 1000 ohms (Fig. 5)

	Groups	Internal Resistance (Ri)	Voltage Drop at 20 mA	Short Circuit Current, I _{sc}	Open Circuit Voltage, Voc
Barrier #1	A-G	340 ohms	6.8 V	93 mA	28 V
Barrier #2	C-G	140 ohms	2.8 V	213 mA	28 V

Table 3. Typical values of barriers rated for different groups.

If repeaters still are not the best solution, there may be other ways to use grounded safety barriers. Either the impedance in the circuit must be reduced or the voltage must be increased. If these alternatives are used, recheck the barrier and transmitter entity parameters to make sure the circuit is safe.

Reducing Impedance

■ **Case 1.** Reduce the conversion resistor. As seen in Fig. 2, only two fixed sources of impedance can be reduced: the conversion resistor or the barrier. One solution is to reduce the conversion resistor to 100 or 50 ohms to obtain maximum voltage readings of 2.0 to 1.0 V respectively. (Example: 20 mA (0.02 A) x 100 ohms = 2 V.) This may be practical for new installations, but it may not be possible for cases where additions are being made to an existing control system.

■ **Case 2.** Select a barrier with lower resistance.

80/20 Rule #5: Many hazardous locations are classified as Groups C-G.

Ignition curves in Groups C-G allow higher rated voltages and current before gases ignite (see Part 1 of this series, October 1992). Barriers designed for hydrogen and other gases classified as Group A or B require higher series resistance than barriers designed for only the more common gases in Groups C and D. Thus, most intrinsically safe instruments should have entity parameters (I_{max}, maximum short circuit current) that are higher for Groups C-G. (As a practical matter, most instrument manufacturers have not taken advantage of this fact.) With the Group C-G rating high-current barriers can be used, which have a lower internal resistance. These barriers have corresponding lower voltage drops but higher I_{sc} (Table 3).

Increasing Voltage Supply

If the voltage supply is increased too much, the barrier may sense a fault and the fuse could blow, interrupting the circuit. Some allowance can be tolerated for increasing the voltage supply on barriers with a nominal rated voltage of 24 VDC.

■ **Case 1: Resistor on the supply side.** When transmitters are first energized, they transmit 4 mA for calibrating zero readings. There always is at least a 1 V drop across the resistor before the supply reaches the barrier. The voltage supply could be increased to 25 to 26 V without the barrier sensing a fault condition. This would allow 1 to 2 additional volts on the circuit.

■ **Case 2: Resistor on the return side.** Since the resistor is on the return side, the barriers receive the total voltage supply. Since this circuit is more sensitive to voltage increases, be careful about increasing the supply above the barrier's nominal rated voltage, V_n.

Before the zener diodes in the barriers reach their rated voltage, there may be some leakage current that could affect the transmitter signals. Diode leakage current values ranging from 1 to 10 μA are listed by the barrier manufacturers. In Case 1, this could mean that the current signal could be deformed by a maximum of 0.025% at 4 mA (1 μA/4 mA).

When the resistor is placed on the return side, leakage current is on the supply side and does not affect the transmitter's 4-20 mA signal.

Transmitters comprise 22% of all intrinsically safe circuits. The next article will feature discrete inputs, also referred to as switching. These represent 32% or almost one-third of all intrinsically safe circuits.

Copyright Instrument Society of America. Intech, March, 1993. All Rights Reserved.



See SIB Series of Intrinsically Safe Transmitters

Making Digital Inputs Intrinsically Safe

Part 4 of this series describes how to make a switch intrinsically safe by using a switch amplifier or a grounded safety barrier.

Paul S. Babiarz

Digital inputs constitute almost one-third of all process signals. They also are known as binary, on-off, 0/1, or simple switching signals where a switch is either opened or closed. The most common examples of these are mechanical or reed contacts, transistors, limit, float, on-off, and pushbutton switches. As defined in paragraph 3.12 of the ANSI/ISA-RP12.6-1987, switches are simple devices that neither generate nor store more than 1.2 V, 0.1 A, 25 mW, or 20 μ J. Since switches are simple devices, they do not have to be approved as intrinsically safe. If they are connected to an approved intrinsically safe associated apparatus (barrier), the circuit is deemed to be intrinsically safe.

To make a switch intrinsically safe, the user may select a switch amplifier or a safety barrier. A switch amplifier is an intrinsically safe relay that solves virtually all switching applications. However, if power is not available in the control panel or if panel space is an important consideration, a grounded safety barrier may be a better choice. There is not a significant cost savings of one alternative over the other. Each has its own advantages and disadvantages, as shown in Table 1.

Switch Amplifiers

The most common application is switching through an intrinsically safe relay (Fig. 1). Relays, which normally are powered by 110 VAC or 24 VDC, have a low voltage and current which are safe at the contact in the hazardous area. When this contact is closed, the relay transfers the signal from the hazardous

location to the non-hazardous side. A closed switch on the hazardous side operates a relay or optocoupler output on the non-hazardous side. The signals are electrically isolated so that grounding is not required.

When proximity switches became a popular means of sensing the presence of objects and materials, the NAMUR-style sensor was developed. Contrary to popular opinion, NAMUR is not an approval standard. It was organized by the German chemical industry to develop operating standards for proximity switches. A NAMUR-style proximity switch is a 2-wire DC sensor that operates at 8.2 V with switch points operating between 1.2 to 2.1 mA. This NAMUR standard later was superseded by the German Standard DIN 199234, Measurement And Control:

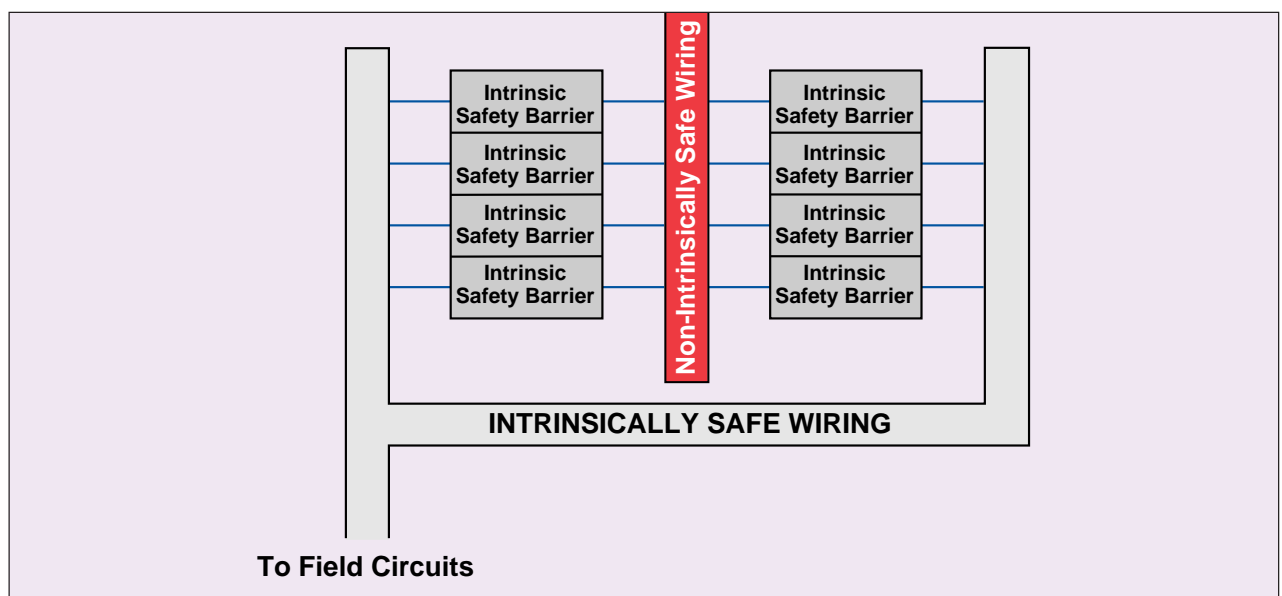

Figure 1. Switch amplifier — 2 channels.

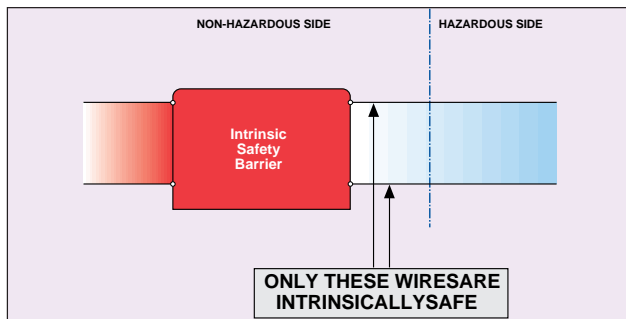

Figure 2. Current sourcing switching.

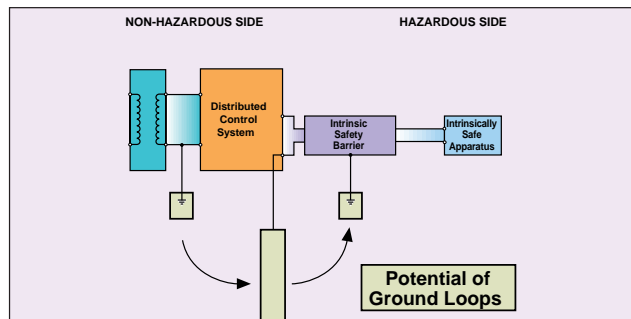

Figure 3. Current sinking switching.

Electrical Sensors Used For Intrinsically Safe 2-Wire DC Systems. Because these switches required a remote amplifier for operation, most switch amplifiers standardized on an intrinsically safe voltage of 8.2 V and current of 8 mA at the contacts in hazardous areas. This provided enough power to operate NAMUR-style proximity switches safely.

The amplifiers are sensitive enough to detect closed contacts in corrosive or abusive areas. Despite the fact that the intrinsically safe voltage and current at the contacts are very low, most modern switch amplifiers will detect a closed contact when the resistance of the circuit is less than 3000 ohms. Intrinsically safe switches can be located a long distance from the switch amplifiers and still function properly.

Switch amplifiers are available with two different output contacts to the safe side, relays and optocouplers. The more commonly used relay versions are applied in slow speed switching to operate smaller pumps, motors, or other electrical devices. Optocouplers are transistors operated by photo diodes to close the output contacts. These outputs have lower contact ratings but an almost infinite switching capability. Optocouplers are used for switching back to a DCS or for high-speed counting operations up to thousands of times per second (KHz).

Switching Through Safety Barriers

When a 110 V supply is not available in the control panel, safety barriers frequently are used for digital inputs back to a DCS. There are two methods of switching: current sourcing or current sinking. Both of these methods can use the same types of barriers that were

used for transmitters (see Part 3 of this series).

The current sourcing method of switching in Fig. 2 could use the same signal and return barrier that was used for 4-20 mA transmitters. The voltage to the switch is supplied through the supply channel. The second channel is used for signal return. A closed switch will close the contact in the DCS. Most digital input signals operate with 24 V and 10 mA. If the same barrier is used for switching as 4-20 mA transmitters, there will be about a 3 to 4 V drop across the barrier.

The barrier used for current sinking switching can be a single-channel DC barrier as seen in Fig. 3. When the switch is open, the DCS input will sense 24 V. When the switch is closed, the DCS will recognize a lower voltage. This lower voltage is calculated as a voltage divider circuit.

Make sure the rated voltage of the barrier, V_n , is equal to or greater

than the voltage supply. Since most switching uses 24 VDC, select a barrier rated at 24 V. The internal resistance of the barrier is not as critical since the current in digital inputs usually is very small. However, it always is good practice to select a barrier with low resistance. Check the approvals of the barriers to make sure that they are rated for the proper hazardous area group location.

Intrinsically safe relays, also referred to as switch amplifiers, can be applied universally for all digital inputs. However, if safety barriers are used, the same barriers used to make analog inputs intrinsically safe can be used for either current sourcing or current sinking switching.

The next article in this series will explain how to make digital outputs intrinsically safe.

Copyright Instrument Society of America. Intech, April, 1993. All Rights Reserved.

Switch Amplifiers	
Advantages	Disadvantages
Simple application	Needs power supply
No ground required	Larger in size
No internal resistance	
LEDs to indicate power and monitor operations	
Sensitive to detect closed contacts in corrosive areas	
Safety Barriers	
Advantages	Disadvantages
Smaller size	Requires grounding
Does not require power supply	Has internal resistance

Table 1. Advantages and disadvantages of switch amplifiers and safety barriers.

Intrinsically Safe Outputs Made Easy

Part 5 of this series explains how to make solenoid valves, LED's, and I/P transducers intrinsically safe.

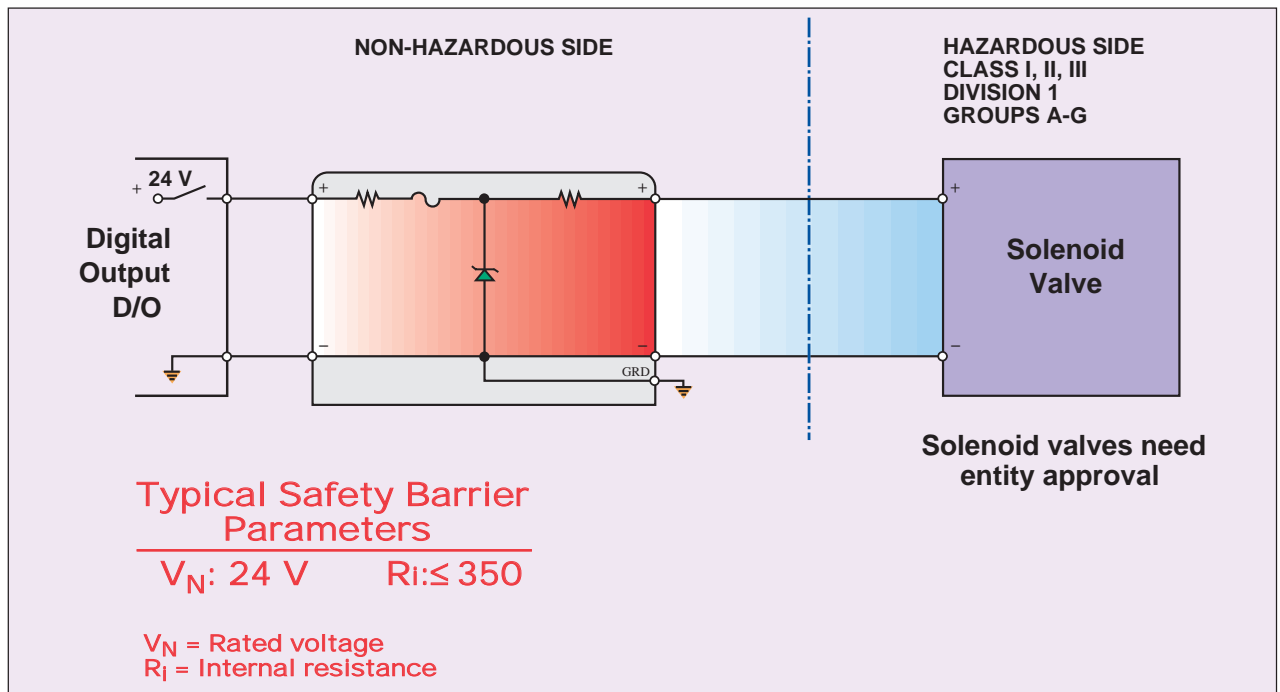

Paul S. Babiarz

Digital outputs refer to closed contacts in a distributed control system (DCS). They transfer a voltage to a process area to operate a field device. The two most commonly used digital output field devices, solenoid valves and LED displays, can easily be made intrinsically safe. For solenoid valves, the same types of barriers are used that make analog and digital inputs (transmitters and switch contacts) intrinsically safe. LED's may require a different barrier.

There is good news and bad news for making circuits (or loops) containing solenoid valves intrinsically safe. The bad news is that unlike transmitters which have minimum operating voltages, valve manufacturers often describe their valves with a nominal operating current or voltage. To select the proper barrier one needs to know the minimum operating characteristics under the most extreme conditions. Without these characteristics it can be quite difficult to select a barrier that will allow the circuit to function properly and still meet the entity parameters of the valves. Conditions that may affect the operating characteristics are high ambient temperatures, position of the actuator, and length of cable runs.

The good news is that there are only a handful of approved intrinsically safe solenoid valves to choose from. For this article, manufacturers tested their intrinsically safe valves with the most common barrier used in analog and digital input circuits — the 24 Vdc barrier with a resistance equal to or less than 350 ohms (Fig. 1).

To determine the correct barrier, start with the basics. Since most digital output circuits operate with 24 Vdc switched on the positive side, use a positive DC barrier rated at 24 Vdc. Knowing the minimum operating current of the valve and the internal impedance of the coil, you can calculate the maximum allowable impedance for the barrier and the cable.

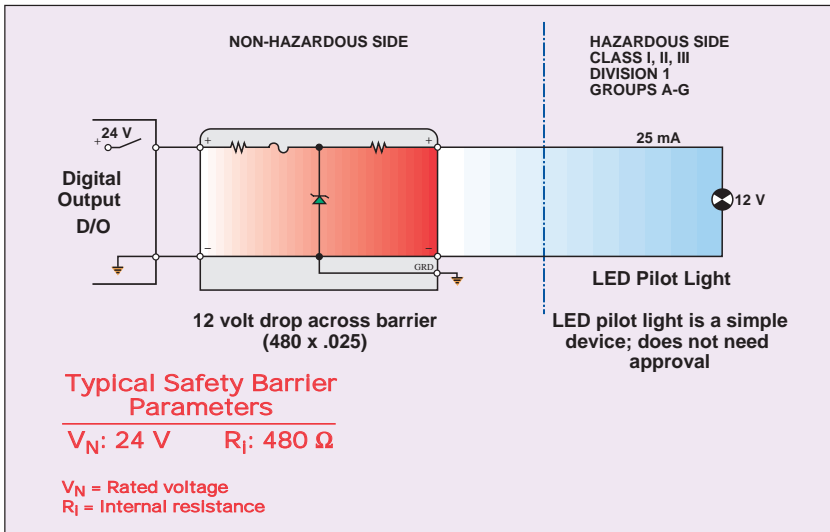

Figure 2. LED pilot light.

For example, assume a valve has a minimum operating current of 28 mA and a coil impedance of 400 ohms. The maximum allowable impedance of the circuit is 857 ohms ($24/.028 = 857$).

If the internal impedance of the solenoid coil is 400 ohms, the allowable impedance of the barrier and cable would be 457 ohms ($857-400 = 457$). The resistance of one mile of #18 AWG wire at 60°C is about 40 ohms (resistance of #18 AWG wire at 60°C is 0.00737 ohms/ft.). This makes the maximum resistance of the barrier $457-40 = 417$ ohms.

Selecting the barrier now is simple:

1. Select a simple DC positive barrier. (The rated voltage should be 24 V.)
2. Calculate the maximum allowable resistance of the barrier as in the example.
3. Confirm that the entity parameters of the solenoid valve match those of the barrier (refer to Part 1 of this series).

Associated Apparatus (barrier)	Apparatus (field device)
Open circuit voltage	$V_{oc} \leq V_{max}$
Short circuit current	$I_{sc} \leq I_{max}$
Allowed capacitance	$C_a \geq C_i$
Allowed inductance	$L_a \geq L_i$

LED's

LED's (light emitting diodes) are simple devices since they do not store energy (capacitance or inductance); therefore, they do not need to be approved. However, they still must be used with safety barriers to make circuits intrinsically safe. Typical LED's are rated at 24, 18, 12, or 6 V and operate at about

25 mA. Since there will always be a voltage drop across the barrier, the best application is to choose an LED rated at less than 24 VDC. Use a barrier rated at 24 V, then subtract the rated voltage of the LED. This difference is the allowable voltage drop on the barrier at the rated current. Use Ohm's Law ($V = IR$) to calculate the internal impedance of the barrier. Example:

- LED rated at 12 V at 25 mA
 - Allowable voltage drop 12 V ($24-12 = 12$)
 - Internal impedance of the barrier = 480 ohms ($12/.025 = 480$)
- Choose a 24 V positive DC barrier with an internal impedance of about 480 ohms (Fig. 2).

Analog Outputs

Analog outputs refer to I/P transducers, also known as I/P's (pronounced "Ida Pease"). An I/P transducer produces a pneumatic output proportional to the electrical current input that it receives. The more current that is applied to the transducer, the more air pressure is allowed into the system to drive a device. As opposed to a solenoid valve which is either in an opened or closed position, a transducer is a proportional valve. I/P transducers are referred to as analog outputs because a variable output, the current signal, is sent from the DCS to the transducer.

I/P transducers need entity approval. They act like resistors in the circuit, so three facts must be known to select the correct barrier: transducer impedance; maximum burden of the driver that sends the current signal; and transducer entity values. Burden, rated in ohms, measures the maximum load the DCS can drive. To select the barrier, use the following characteristics:

- Transducer impedance is 150 ohms
- Burden of the drive is 1000 ohms

The barrier must have an internal resistance less than 850 ohms ($1000-150 = 850$). Verify the rated voltage of the barrier by calculating the voltage drop of the circuit. For example, use the same barrier and cable values as in the solenoid valve example. The total impedance (impedance of barrier + transducer + cable) of the circuit would be

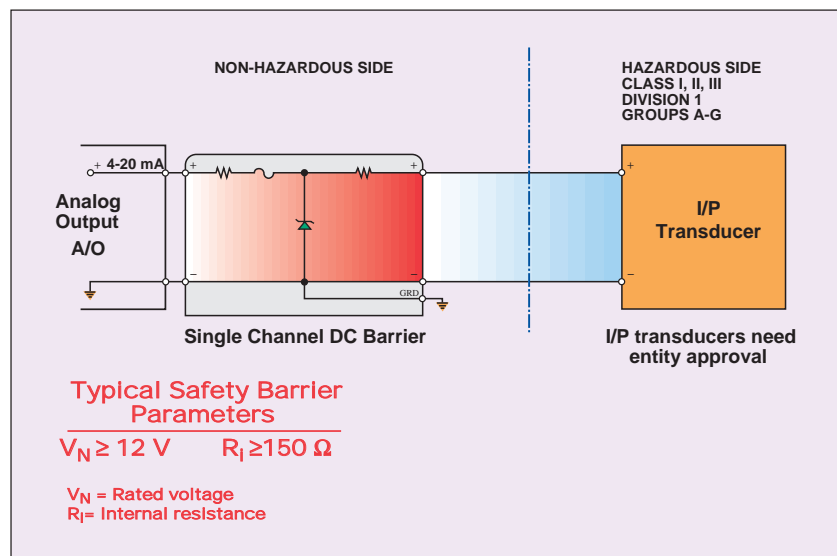

Figure 3. 4-20 mA I/P transducer.

Device	Barrier Type	Rated Voltage	Internal Resistance	Notes (IT = INTECH)
Thermocouples	AC	>1 V	<1000*	Thermocouples are simple devices; do not need approval.
RTD's	AC	>1 V	<1000*	RTD's are simple devices; do not need approval.
Digital inputs	switch amplifiers			Dry contacts are simple devices; do not need approval.
D/I - current sourcing	supply & return	24	350**	Dry contacts are simple devices; do not need approval.
D/I - current sinking	DC	24	350**	Dry contacts are simple devices; do not need approval.
A/I transmitters	supply & return	24	350	Transmitters need approval. Check entity parameters. Conversion resistor of 250 ohms is on negative side. Minimum lift-off voltage of transmitter is 12 or less.
A/I transmitters	DC	24	350	Same, except conversion resistor is on + side.
D/O solenoid valves	DC	24	350	Solenoid valves need approval. Check entity parameters.
A/O transducers	DC	>12	>150	Transducers need approval. Check entity parameters and DCS burden.
* Select a barrier with a low resistance.				
** Other barriers with a different resistance can be used. However, these barriers match those of the analog inputs.				

Table 1. Guide to selecting grounded safety barriers.

540 ohms (350 + 150 + 40). At the maximum current of 20 mA, the voltage drop would be 10.8 V (540 x 0.020 = 10.8). Select a barrier rated equal to or higher than 10.8 V. A barrier rated at 12 V or higher with an internal resistance of 150 ohms also would be a good choice (Fig. 3). Confirm that the entity parameters of the barrier correspond with those of the transducer.

This series of articles has shown how the most common applications of temperature measurements and analog or digital inputs/outputs can be made intrinsically safe with a few intrinsic safety barriers. Selection is simple:

1. Determine if the field device is a simple or nonsimple (energy

storing) device that needs approval and has entity parameters.

2. Select the type of barrier needed to protect the individual ungrounded lines of the circuit. Normally, temperature sensors use an AC barrier. For analog inputs and current sourcing switching, use the supply and return barrier. The remainder (analog and digital outputs and some switching circuits) require DC barriers.
3. Select a barrier with a rated voltage equal to or greater than the voltage of the circuit.
4. Confirm that the internal resistance of the barrier will allow enough voltage for the field device to operate properly.

5. Confirm that the entity parameters of the barrier match those of the field device.

Use Table 1 as a guide in selecting grounded safety barriers. There will always be exceptions to these guidelines, so verify your selection with the manufacturer of the barriers or field devices.

The last installment in this series will discuss the general rules of grounding, installation, and maintenance of intrinsically safe systems.

Copyright Instrument Society of America. Intech, September, 1993. All Rights Reserved.

Installing Intrinsically Safe Systems

Part 6 of this series summarizes the major points of barrier replacement, wiring, installation, grounding, sealing, maintenance, and troubleshooting of intrinsically safe systems.

Paul S. Babiarz

We have shown how an intrinsically safe circuit is designed for most common applications. Now the intrinsically safe system must be properly installed and provisions must be made to maintain and troubleshoot it. These procedures are discussed in detail in Article 504 of the National Electrical Code (NEC) and the ANSI/ISA RP 12.6-1987 *Recommended Practice — Installation of Intrinsically Safe Systems For Hazardous (Classified) Locations*.

Wiring

Intrinsically safe circuits may be wired in the same manner as comparable circuits installed for unclassified locations with two exceptions summarized as *separation* and *identification*. These wiring practices are simple and clear; however, they often are overlooked and are the source of potential problems.

The intrinsically safe conductors must be separated from all other wiring by placing them in separate conduits or by a separation of 2 inches of air space. Within an enclosure the conductors can be separated by a grounded metal or insulated partition (Fig. 1).

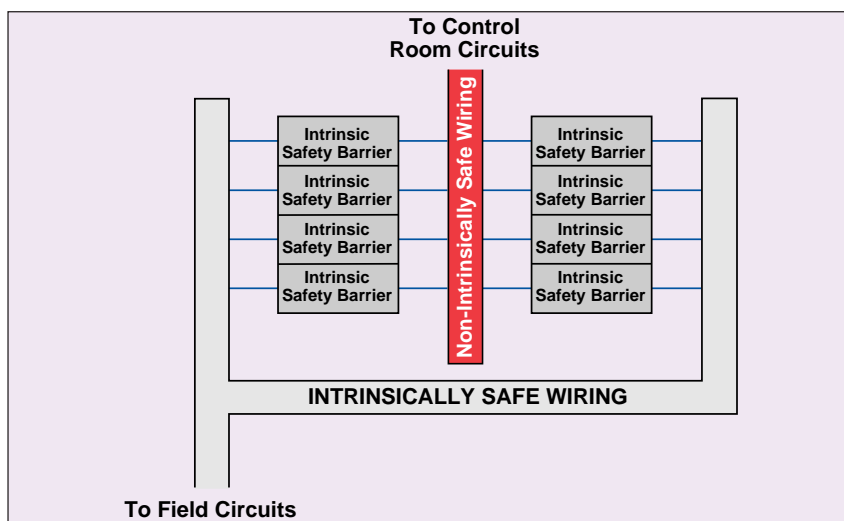

Figure 1. Suggested panel arrangement using separate wireways.

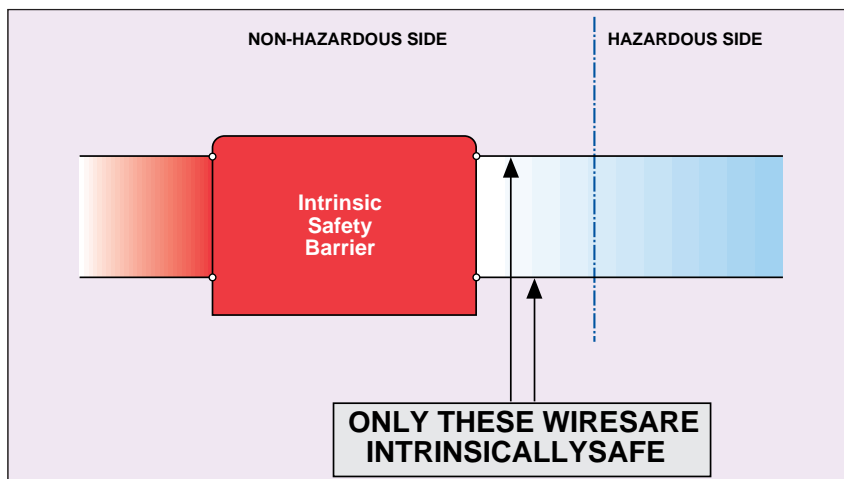

Figure 2. Barrier installation.

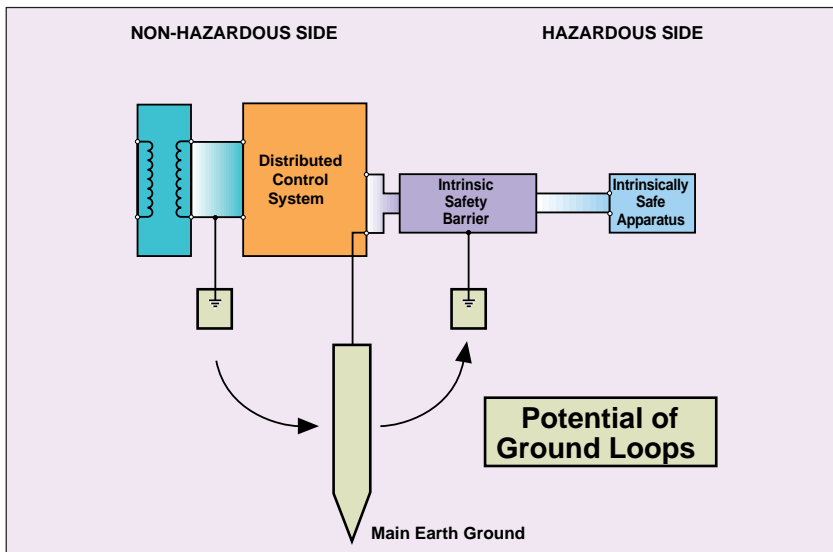

Figure 3. Unacceptable grounding.

Intrinsically safe wiring may be light blue when no other conductors colored light blue are used. The raceways, cable trays, open wiring, and terminal boxes must be labeled *Intrinsically Safe Wiring* to prevent unintentional interference with the circuits. The spacing between the labels should not exceed 25 ft.

Barrier Installation

The barriers normally are installed in a dust- and moisture-free NEMA 4 or 12 enclosure located in the nonhazardous area. Only the barrier outputs are intrinsically safe. Conductive dust or moisture could lessen the required distance of 2 in. between intrinsically safe and nonintrinsically safe conductors (Fig. 2). The enclosure should be as close as possible to the hazardous area to minimize cable runs and increased capacitance of the circuit. If they are installed in a hazardous area, they must be in the proper enclosure suited for that area.

Grounding

First determine if the intrinsically safe barriers used in the system are grounded or isolated. The isolated barriers normally are larger, more expensive, and do not require a ground for safety. The grounded safety barriers are smaller and less expensive, but require a ground to divert the excess energy. The main rules of grounding intrinsically safe systems are:

- The ground path must have less than 1 ohm of resistance from the furthest barrier to the main grounding electrode.

- The grounding conductor must be a minimum 12 AWG.
 - All ground path connections must be secure, permanent, visible, and accessible for routine inspection.
 - A separate isolated ground conductor normally is required since the normal protective ground conductor (green or yellow/green wire) may not be at the same ground potential because of the voltage drop from fault currents in other equipment.
 - For installations designed to Canadian standards, the Canadian Electrical Code (Appendix F) recommends redundant grounding conductors.
- A poor grounding system can

influence the function of the system by creating noise on the circuit or modifying the signals. Fig. 3 shows an improperly grounded system. The numerous grounding points create ground loops which can modify the signals and induce stray voltages into the intrinsically safe circuits. The correct method of grounding is shown in Fig. 4 where all the grounds are tied together at one single point in the system.

Sealing

The requirements for sealing intrinsically safe circuits have been discussed by a panel of experts and published in "Seals for Intrinsically Safe Circuits," *EC&M*, September 1992, pp. 48-49. The panel's conclusion is that seals are required to prevent the transmission of gases and vapors from the hazardous area to the nonhazardous area, not to prevent passage of flames from explosions. Explosion-proof seals are not required as long as there is some other mechanical means of preventing the passage of gases such as positive pressure in the control room and/or application of an approved mastic at cable terminations and between the cable and raceway. Many experts generally agree that a commercially available silicon caulk is a suitable mastic which would minimize the passage of gases. This must, however, be acceptable to the authority having jurisdiction.

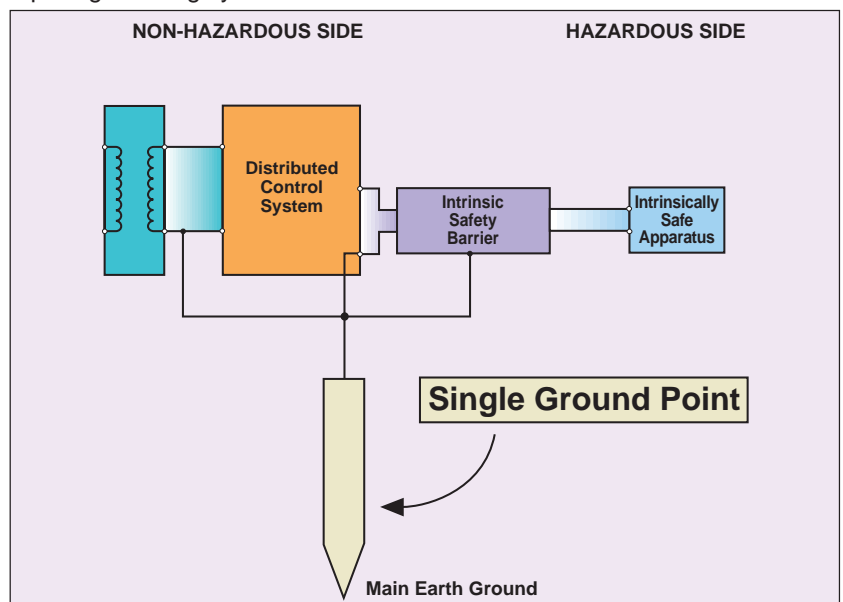

Figure 4. Acceptable grounding.

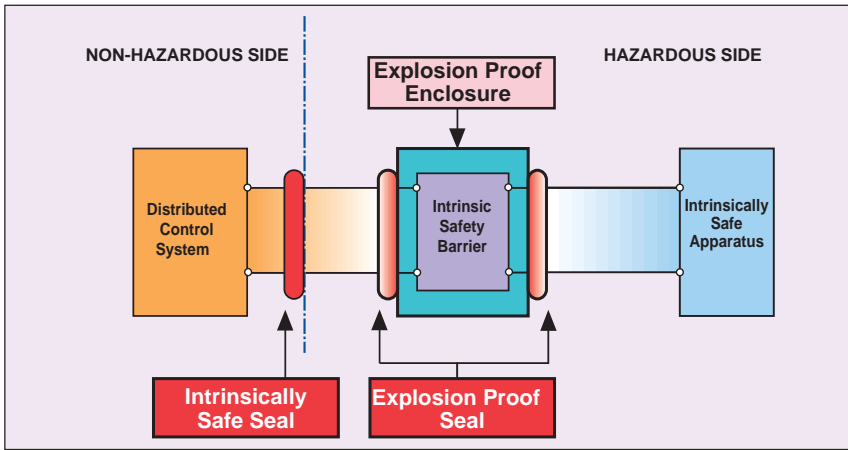

Figure 5. Mounting in a hazardous area.

When barriers are installed in explosion-proof enclosures, which are located in the hazardous area, explosion-proof seals are required on the enclosure (Fig. 5). Since other conduits containing nonintrinsically safe conductors between the hazardous and nonhazardous areas require explosion-proof seals, it is good practice to maintain consistency and install explosion-proof seals on the conduits containing intrinsically safe conductors also. The exception to this would be where multiconductor shielded cable is used. This cable may be difficult to seal in some explosion-proof fittings. However, it will be necessary to seal both the cable terminations and between the cable and raceway to minimize the passage of gases, vapors, or dust.

Maintenance

No special maintenance of intrinsically safe systems is

required. Once a year the barriers should be checked to ensure that the connections are tight, the ground wiring has less than one ohm of resistance, and the barriers are free from moisture and dirt. Check the panel and conduits for separation and identification of the intrinsically safe wiring. Never test the barrier with an ohmmeter or other test instrument while it is connected in the circuit (Fig. 6). This bypasses the barrier and could induce voltages into the intrinsically safe wiring.

Troubleshooting

If the intrinsic safety circuit does not operate properly once it is completed and energized, follow these troubleshooting guidelines:

- Make sure the connections are tight.
- Check the wiring to the appropriate terminals against the control wiring diagram. A control

wiring diagram is defined by the NEC as “a drawing or other document provided by the manufacturer of the intrinsically safe or associated apparatus that details the allowed interconnections between the intrinsically safe and associated apparatus.” These diagrams are easier to obtain than in the past. Make sure that one of the manufacturers provides not only diagrams which show the interconnections between the field device and barriers, but also wiring diagrams which demonstrate that the circuit functions properly and is safe by comparing the safety parameters of the field device and the barriers.

- Make sure the circuit is powered.
- Check to see if the resistance in the barrier is too high for the circuit. As stated in the previous articles in this series, circuits are analyzed for the proper loop resistance (barrier and cable) and supply voltages. If the circuit does not operate properly, check the circuit against the design in the control wiring diagram.
- Check for a blown barrier fuse. This is accomplished by disconnecting the barrier from the circuit and measuring the end-to-end resistance of the barrier. If the ohmmeter registers an infinite resistance, the fuse in the barrier is blown. The fuse has opened because of a fault in the circuit, so reevaluate the entire circuit before reinstalling a new barrier.

Barrier Replacement

If the barrier's fuse has opened, it usually is the result of excessive voltage being applied to the barrier. This causes the diode to conduct, which results in high current in the fuse. After determining the cause of the excess voltage, the barrier must be replaced. The procedure is to disconnect the wiring from the safety barriers in the proper order of nonhazardous terminal first, hazardous terminals next, and the ground last. Cover the bare wire ends with tape, replace the barrier, and then reverse the procedure to mount the new barrier. Always install the ground first and disconnect the ground last.

Copyright Instrument Society of America. Intech, October, 1993. All Rights Reserved.

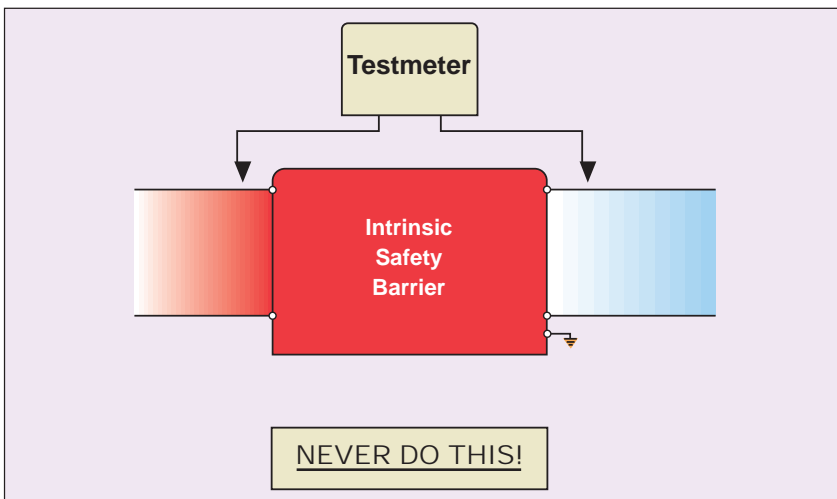

Figure 6. The barrier should never be tested with an ohmmeter or other instrument while it is connected in circuit.